

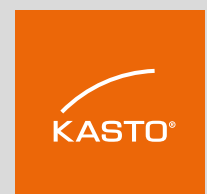

Production circular saws

High-tech in series



KASTO production circular saw overview

Efficient and reliable: KASTO circular saws

KASTO provides powerful circular sawing machines for efficient processing of bar materials with HSS and carbide tools for high-quality steels and materials that are difficult-to-cut such as titanium etc. for small and large cutting quantities.

Our high-performance automatic circular saws for cost-effective large-scale sawing of steel and non-ferrous metals such as aluminium.

The integration of our KASTO*sort* robot handling system with KASTO circular saws enables automated production.

The platform-independent KASTO*app* web application gives you a live status overview of your sawing machines.

KASTO*app* has the overview

Live status overview of your sawing machine

No installation is required to use the KASTO*app*. Thanks to its responsive design, it adapts flexibly to the size of the end device. Using a browser on a smartphone, tablet or computer, users can query and monitor the status of the sawing machines at any time, from anywhere, and can react quickly if necessary.

Quick finder for the right machine series

	KASTO <i>flex</i>	KASTO <i>gripspeed</i>	KASTO <i>owa</i>	KASTO <i>speed</i>	KASTO <i>variospeed</i>
Page number	4	10	12	14	22
Single cut, fully automatic	■	■	□	□	■
Serial cut, fully automatic	■	■	■	■	■
KASTO <i>sort</i> connection	□	■	■	■	■
KASTO <i>app</i> functionality	■	■	■	■	■
Cut type					
90° cut	■	■	■	■	■
Mitre cut on both sides	■	-	-	-	-
Material					
Non-ferrous metals + plastics	□	□	■	■	■
Construction steels	■	■	■	■	■
Tool steels	□	■	■	■	■
Stainless steels	□	■	■	■	■
Steels for special use	-	■	■	■	■

The clearly and intuitively structured KASTOapp provides users with key information at a glance on all sawing machines that are equipped with the latest control system. It is also possible for several users to access information at the same time. If a sawing machine is operating in automatic mode, the KASTOapp can also access the information stored on the current order in the respective machine control system. This gives the user precise information about all relevant parameters during sawing operation. Further information can also be found in our brochure "KASTO Smart Solutions"

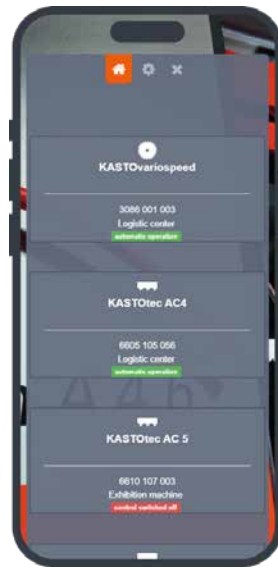

Machine and status overview

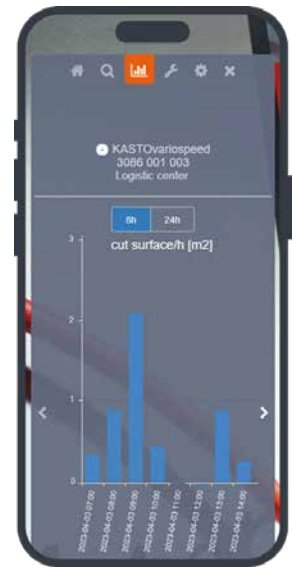

History of shift/day



KASTOflex



KASTOgripspeed

KASTOspeed

KASTOvariospeed





KASTOflex

Universal, semi or fully automatic HSS circular saw

Technical Data		KASTOflex U	KASTOflex A	KASTOflex F
Cutting range, round at 90°	mm	150	150	150
Cutting range, square at 90°	mm	140 x 140	140 x 140	140 x 140
Cutting range, flat (H x W) at 90°	mm	25 x 350	100 x 200	100 x 200
Cutting range, round at 45°	mm	145	145	145
Cutting range, square at 45°	mm	120 x 120	120 x 120	120 x 120
Cutting range, flat (H x W) at 45°	mm	30 x 280	80 x 160	80 x 160
Cutting range, round at 60°	mm	140	115	115
Cutting range, square at 60°	mm	110 x 110	100 x 100	100 x 100
Cutting range, flat (H x W) at 60°	mm	50 x 170	60 x 120	60 x 120
In automatic mode, shortest residual piece length 90°	mm	-	35	35
In automatic mode, shortest residual piece length 45°	mm	-	95	95
Smallest diameter to saw	mm	10	8	8
Mitre swivel range		manual +/- 90°	manual +/- 60°	automatic +/- 60°
Saw feed speed range	mm / min	10 - 520	10 - 520	10 - 520
Material feed length straight cut	mm	-	up to 2,030	up to 2,030
Material feed length mitre cut	mm	-	up to 1,970	up to 1,970
Cutting speed (opt. infinitely adjustable)	m / min	10 - 60	10 - 60	10 - 60
Total connected load	kW	6 / 8	6 / 8	8
Saw motor power	kW	1.4 / 2.2 (opt. 4.0)	1.4 / 2.2 (opt. 4.0)	Frequency mode 4.0
Saw blade size (Ø 350 mm opt.)	mm	Ø 400 to 450	Ø 400 to 450	Ø 400 to 450
Length x width x height	mm	1,795 x 1,400 x 1,900	3,660 x 1,200 x 1,900	4,800 x 1,500 x 1,900
Material support height	mm	1,050	1,050	1,050
Weight	kg	1,350	2,500	2,700



Versatile circular saw machine

For workshop and series production

The KASTOflex U semi-automatic version forms the basis of the machine. Its centred support table, which can be rotated to the left and right, allows you to set mitre cuts in the range of $\pm 90^\circ$ (180° swivel range) very quickly and at precise angles. Another special feature is the saw blade that moves from bottom to top. This is driven via a precise, four-stage saw gear, whose helical, hardened and ground gears run in an oil bath, either by a pole-changing (cutting speeds 12 to 24 m/min) or a frequency-controlled three-phase motor (10 to 60 m/min; 4kW). In connection with the fine-adjusting vertical vice, solid material as well as pipes and profiles can be cut to precision with ease.

The rotatable support table is equipped with a precise 4-point complete roller bearing. The saw gear swivel axis is preloaded via cone bearings. Solid steel or segment saw blades with a diameter of 350 to 450 mm are used.



KASTOflex U

An all-rounder from cut to cut



Universal, fast and precise: the KASTOflex U semi-automatic circular saw sets high performance standards in workshops and factories, for sawing profiles, pipes and solid material, both in 90° and in mitre cuts on both sides.

It clamps workpieces quickly using a button with a hydraulic long/short-stroke vertical vice. Rotary table swivel range 180°, manual angle setting via vernier, easy turning thanks to four-point complete roller bearing. Fixed stops for 90° and 45° right / left, other stops available on request.

Infinitely adjustable hydraulic constant saw feed control. No saw blade changes, no set-up times in mixed mode with profile/solid material. Simple electronic cutting path limitation using the "teach-in" method.

Direct drive by means of a pole-changing three-phase motor, four-stage, helical spur gear with hardened and ground gears running in an oil bath, infinitely adjustable cutting speed on request, frequency-controlled (option).

Technical Data		KASTOflex U
Cutting range at 90° (round, square, flat)	mm	150 / 140 x 140 / 350 x 25
Cutting range, at 45° (round, square, flat)	mm	145 / 120 x 120 / 280 x 30
Cutting range, at 60° (round, square, flat)	mm	140 / 110 x 110 / 170 x 50
Total connected load	kW	6 / 8
Saw motor power	kW	1.4 / 2.2 (opt. 4.0)
Saw blade size (Ø 350 mm opt.)	mm	Ø 400 to 450
Length x width x height	mm	1,795 x 1,400 x 1,900

KASTOflex A.

Whether single cuts or series cuts, fast and flexible



Universal and economical, the automatic circular saw for single and series cuts.

The ergonomic working height and the good accessibility due to the full enclosure that can be opened wide allow easy work with flexible single cuts. Safety thanks to full enclosure with a very good view of the working area in automatic mode. The material feed of up to 2,000 mm per stroke keeps fetching to a minimum with long cut pieces. Exact cut piece lengths are guaranteed by the stable material feed, which is driven by a ball screw and linearly guided.

The material feed vice, which opens on both sides, ensures a contact-free return stroke when fetching the next cut piece length. A minimum residual piece length of 35 mm in 90° cuts and just 95 mm in 45° mitre cuts reduces material consumption in automatic mode. The centrally arranged control panel with the KASTO sawing machine control enables easy order entry.

Technical Data		KASTOflex A
Cutting range at 90° (round, square, flat)	mm	150 / 140 x 140 / 200 x 100
Cutting range, at 45° (round, square, flat)	mm	145 / 120 x 120 / 160 x 80
Cutting range, at 60° (round, square, flat)	mm	115 / 100 x 100 / 120 x 60
Total connected load	kW	6 / 8
Saw motor power	kW	1.4 / 2.2 (opt. 4.0)
Saw blade size (Ø 350 mm opt.)	mm	Ø 400 to 450
Length x width x height	mm	3,660 x 1,200 x 1,900



KASTOflex F

Flexible, fully automatic circular mitre saw machine.

Fully automatic operation is here. For fully automatic 90° and mitre cutting. Efficiency and economy from the roller conveyor or magazine all the way to the cut piece container. Independent of cut piece number, saw orders can be processed in unstaffed operation after material feed.

Optionally, infeed roller conveyors and, depending on application, different magazines are available for material supply. Direct integration into a KASTOcenter (combination saw and storage system) also opens up further options with operator-free material feed. Cut pieces are separated from trim cuts, intermediate pieces and remnants and can, depending on require-

ments, be sorted and placed into different containers or stacked. Easy order programming of the KASTO sawing machine control thanks to graphic display of the cutting geometry and the calculated quantity of material per order. The sawing parameters and the cutting depths are automatically assigned based on the stored material master records.

Technical Data		KASTOflex F
Cutting range at 90° (round, square, flat)	mm	150 / 140 x 140 / 200 x 100
Cutting range, at 45° (round, square, flat)	mm	145 / 120 x 120 / 160 x 80
Cutting range, at 60° (round, square, flat)	mm	115 / 100 x 100 / 120 x 60
Total connected load	kW	6 / 8
Saw motor power	kW	1.4 / 2.2 (opt. 4.0)
Saw blade size (Ø 350 mm opt.)	mm	Ø 400 to 450
Length x width x height	mm	4,800 x 1,500 x 1,900

All benefits at a glance:

- Independent of cut piece number, saw orders can be processed in unstaffed operation after material feed (KASTOflex A and F)
- The KASTO *ProControl* sawing machine control allows easy order programming thanks to the graphical cutting geometry representation (KASTOflex A and F)
- Flexibility and maximum efficiency in serial cuts.

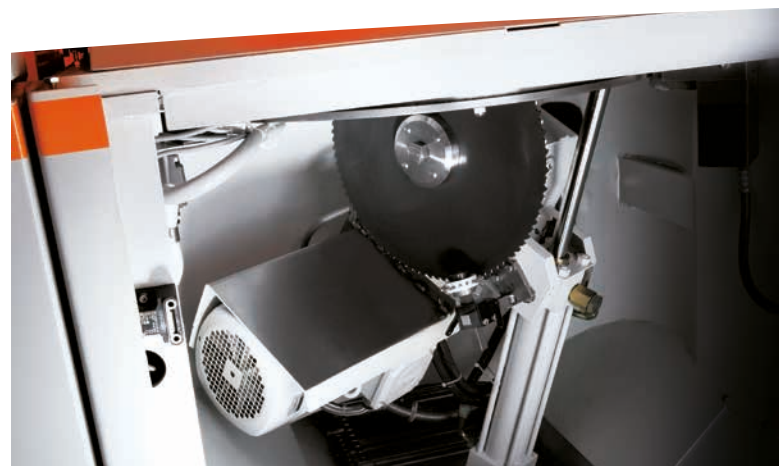

Generous access for easy saw blade changes



KASTOflex A: Vertical vice and material feed unit



Vice for material feed on KASTOflex A and KASTOflex F



Cut piece sorting plate conveyor for the KASTOflex F

Universal magazine for KASTOflex F with restoring buffer

Control of the KASTOflex F, the KASTO *ProControl*: Order entry with geometric representation of the mitre cut

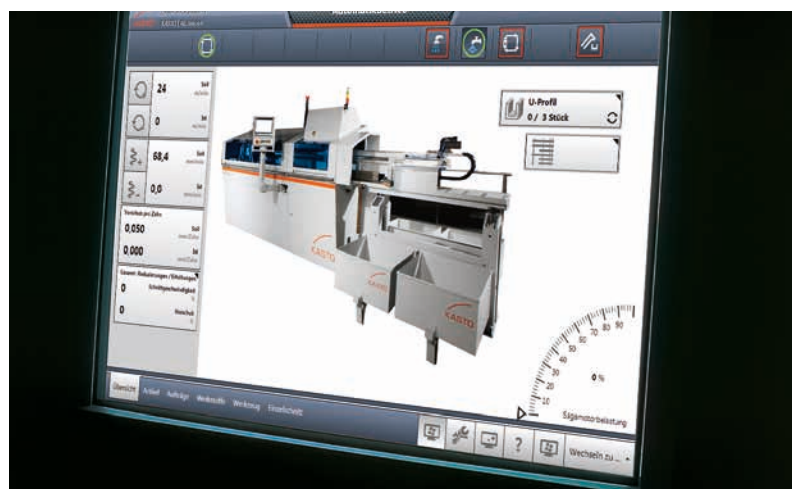
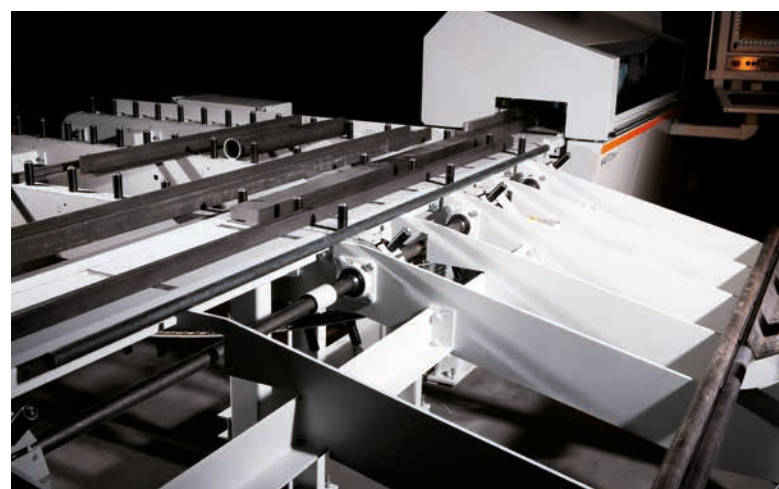



KASTOgripspeed C 10

High-performance automatic circular saw with feed vice technology and touch screen programming

For fast sawing of precise cut pieces in large series with tensile strengths of up to 1,400 N/mm².

clamping force, it is also possible to securely fix and clamp thin-walled tubes/profiles, for example.

The thin-cutting technology has the advantage that even thin or thin-walled materials can be sawn flexibly and efficiently, which increases the application and usage options of the KASTOgripspeed. The infinitely adjustable workpiece clamping provides valuable support here. In the range of 2,000 to 12,500 N

Technical Data		KASTOgripspeed C 10
Cutting range, round	mm	15 – 100
Cutting range, square	mm	15 – 80
Saw blade diameter	mm	360
Cutting width	mm	2.5
Saw blade drive	kW	11
Cutting speed	m/min	17 – 175
Feed speed	m/min	10 – 4,000
Material feed length simple	mm	500
Shortest cut piece length	mm	8
Multiple feed	mm	up to 9,999
Shortest residual piece length	mm	75



Saw blade with guide and tension



Saw unit

Touch Screen KASTO ProControl

Loading discs

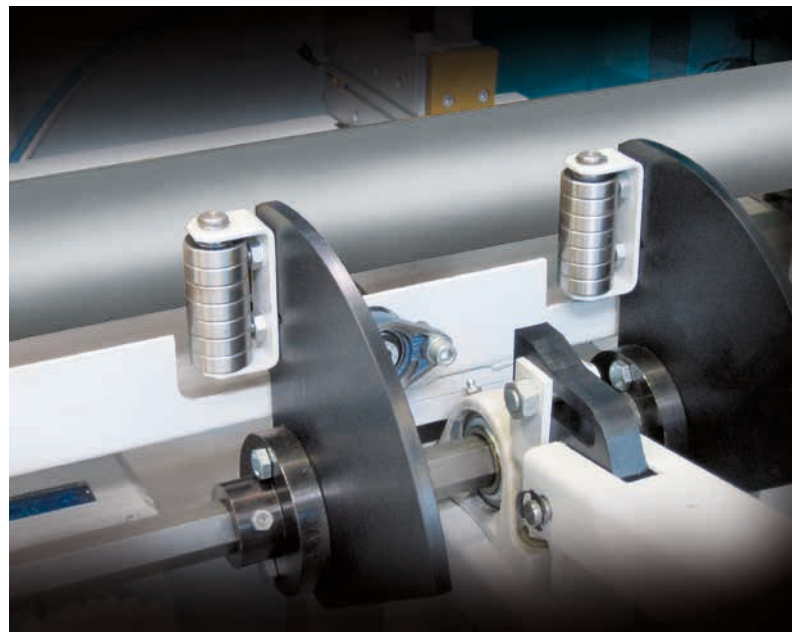
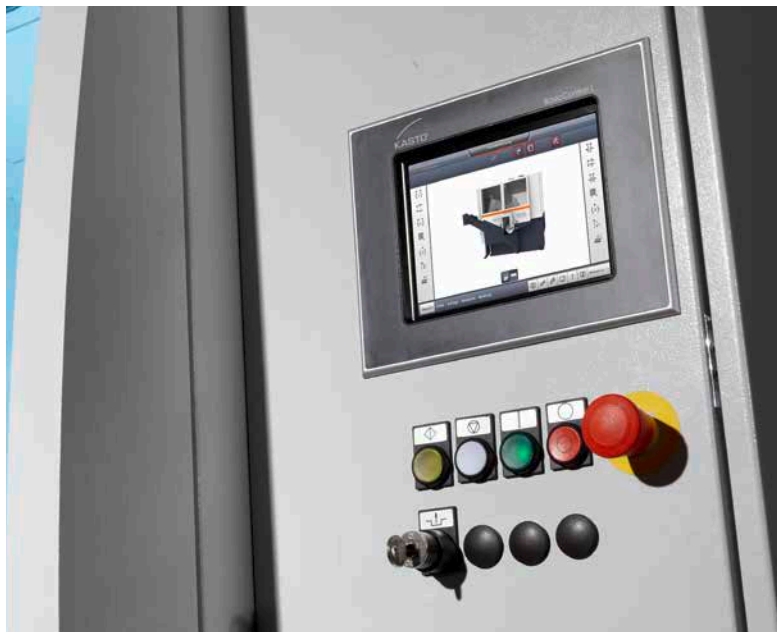



KASTOwa

Automatic circular saw for quick sawing of precise cut pieces in large series

Sawing in large series, quickly and inexpensively. **KASTOwa M:** Automatic circular saw for sawing precise cut pieces of brass, copper and aluminium with carbide-tipped and HSS saw blades.

The unique arrangement of the saw gear and the four-point workpiece clamping guarantee the shortest saw movement. The fast bar feed, hydraulically dampened measuring stop and fast cycling ensure a high output of precise cut pieces and high availability.

ty. Various options are available for bar and cut piece handling and interlinking with processing machines.

KASTOwa C: Automatic circular saw for quick sawing of steel with tensile strengths of up to 1,400 N/mm², in precise cut pieces in large series, including high-alloyed, with carbide disposable saw blades and 2 mm cutting width. Also suitable for sawing with HSS solid steel saw blades, coated, with a maximum cutting width of 3 mm, e.g. of steel pipes.

Technical Data		KASTOwa C 7	KASTOwa M 9
Material		Steel	Non-ferrous metals
Saw blade type		Carbide-tipped	HSS solid steel / carbide-tipped
Saw blade diameter	mm	250 / 285	250 / 285 / 315
Cutting range			
round	mm	15 - 70	15 - 90
square	mm	15 - 60	15 - 80
flat	mm	15 x 15 - 70 x 60	15 x 15 - 120 x 75
Cutting speed	m/min	40 - 160	40 - 160
Saw blade drive	kW	5.5	15
Min. residual piece length	mm	65	65

(further cutting speed ranges and saw blade drive motors, also frequency-controlled, on request)

Chip disposal and environmental protection

Robust chip conveyors and powerful suction devices in various designs are available for the disposal of chips produced during sawing.

To reduce the air emission values, electrostatic air filters are used.



Disposable carbide saw blades



Machine control with technology input via touch screen

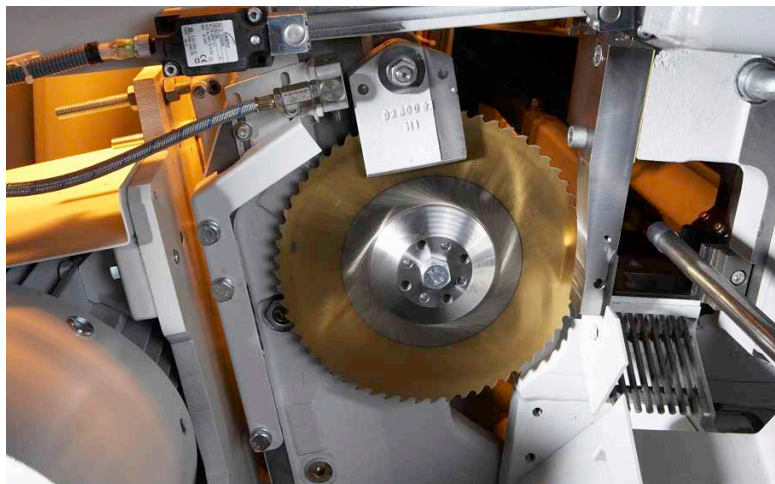

HSS solid steel saw blades for sawing non-ferrous metals and measuring stop



Loading table (basic features)

Bundle loader with material in laying position

Flat magazine for rectangular and special profiles





KASTOspeed

High-performance circular saw machines for cost-effective mass production cutting of steel and non-ferrous metals.

Technical Data		<i>C 9</i>	<i>M 9</i>	<i>C 15</i>	<i>M 15</i>
Material		Steel	Non-ferrous metals	Steel	Non-ferrous metals
Saw blade type		Carbide-tipped	Carbide-tipped / HSS full	Carbide-tipped	Carbide-tipped / HSS full
Saw blade diameter	mm	250 / 285 / 315	250 / 285 / 315	360 / 425 / 460	360 / 425 / 460
Cutting width	mm	2.0 / 2.0 / 2.5	up to 3.5	2.6 or 2.7	2.6 or 2.7
Cutting range					
round	mm	15 - 90	15 - 90	20 - 153	20 - 153
square	mm	15 - 80	15 - 80	20 - 135	20 - 135
rectangle (HxW)	mm	15x15 - 85x80	15x15 - 120x75	20x 20 - 155x135	20x 20 - 155x135
Shortest residual piece length	mm	50	50	70	70
Dimensions and weights					
Length	mm	1,600	1,600	approx. 1,700	approx. 1,700
Width	mm	1,950	1,950	approx. 2,500	approx. 2,500
Height	mm	2,150	2,150	2,050	2,050
Weight	kg	2,600	2,600	3,000	3,000
Performance characteristics					
Saw blade drive power*	kW	7.5	25	18.5	30
Cutting speed	m/min	16 - 225	850 - 3,900	20 - 160	830 - 4,100
Saw feed, infinitely adjustable	mm/min	approx. 50-2,000	approx. 125 - 7,500	30 - 2,000	300 - 7,500
Saw feed rapid return	mm/min	approx. 8,500	approx. 10,000	approx. 10,000	approx. 10,000
Feed cart rapid return	m/min	150	150	120	120
Workpiece clamping	N	2,000-10,000	2,000-10,000	20,000	20,000

(other cutting speed ranges and saw blade drive motors on request)
* Basic machine up to 300 mm cut piece length, without feed device)



High performance at high speed: KASTO*speed* automatic circular saws

KASTO*speed*: Fast and precise mass-production sawing. KASTO's competence helps the world get building. Press or forging works, manufacturers of fittings and electrical parts, the steel trade and almost all car suppliers use the KASTO*speed* when cutting pieces of steel and non-ferrous metals. The automatic circular saws impress with their minimal cycle times and

enable millions of precise cuts every year in two to three-shift operation. Thanks to their high reliability and precision in continuous operation, KASTO*speed* automatic saws are among the best-selling mass cutting circular saws in their class worldwide.

Powerful solutions for high efficiency

KASTO*speed* high-volume sawing machines set standards for mass cutting steel, aluminium, brass and copper. HSS solid steel and carbide-tipped saw blades are used on the automatic saw for specific tasks and, together with the robust design, ensure maximum cutting performance. Further KASTO*speed*

features: short non-productive times thanks to a fast material feed cart and a hydraulically dampened measuring stop.

KASTOspeed C 9 / KASTOspeed M 9

For material cross-sections up to 90 mm



The KASTOspeed 9 produces large series of steel or non-ferrous metal cut pieces with a material cross-section of up to Ø 90 mm in continuous operation. HSS solid steel or carbide disposable saw blades with adapted cutting speeds are used depending on the machinability of the material and the production requirements.

The optimal positioning of the saw gear and the four-point workpiece clamping guarantee the shortest saw movement. Various options and linking with processing machines are available for bar and cut piece handling.

Technical Data		C 9	M 9
Material		Steel	Non-ferrous metals
Saw blade type		Carbide-tipped	Carbide-tipped / HSS full
Saw blade diameter	mm	250 / 285 / 315	250 / 285 / 315
Cutting width	mm	2.0 / 2.0 / 2.5	up to 3.5
Cutting range			
round	mm	15 - 90	15 - 90
square	mm	15 - 80	15 - 80
rectangle (HxW)	mm	15x15 - 85x80	15x15 - 120x75
Shortest residual piece length	mm	50	50



Inclined magazine with loading discs and infeed roller conveyor

Working area with adjustable saw blade guide (patented),
Measuring stop and cut piece outfeed conveyor (option)



Machine control with technology input via touch screen

Feed cart with linear guide system and material guide rail

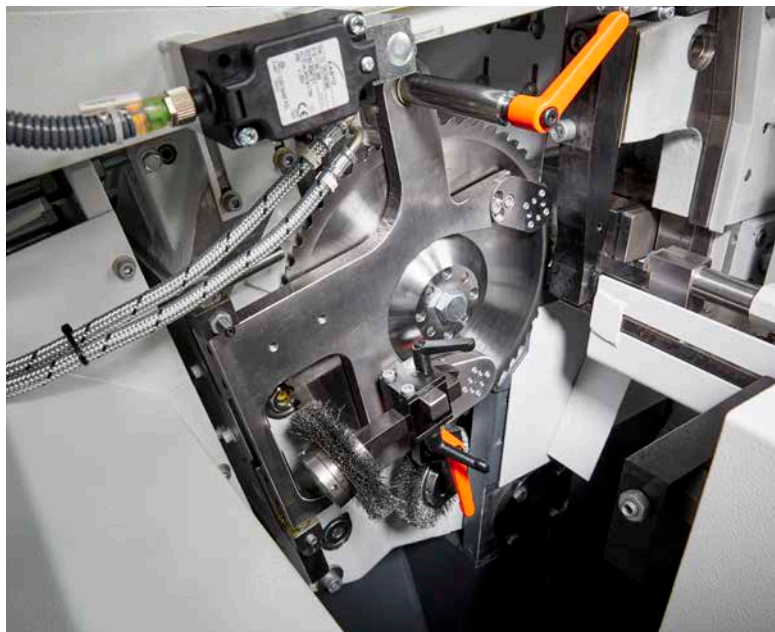

KASTOspeed C 15 / KASTOspeed M 15

For material cross-sections up to 150 mm



KASTOspeed 15 automatic circular saws meet the highest standards of performance and efficiency when sawing steel with tensile strengths of up to approx. 1,400 N/mm, and of high-alloy steels with carbide disposable saw blades and HSS solid steel saw blades. The M 15 version is used for sawing non-ferrous metals with HSS and/or carbide-tipped saw blades. The stable machine design with the helical high-performance spur gear in combination with a hydraulically damped measuring stop and a quickly

positionable feed cart ensures maximum output for precise cuts.

In addition to our proven core solutions, extensive, customer-oriented peripheral solutions are available for efficient sawing. A user-friendly brand PLC control with a clear operator panel is integrated for the simple and clear entry of sawing orders.

Technical Data		C 15	M 15
Material		Steel	Non-ferrous metals
Saw blade type		Carbide-tipped	Carbide-tipped / HSS full
Saw blade diameter	mm	360 / 425 / 460	360 / 425 / 460
Cutting width	mm	2.6 or 2.7	2.6 or 2.7
Cutting range			
round	mm	20 - 153	20 - 153
square	mm	20 - 135	20 - 135
rectangle (HxW)	mm	20x 20 - 155x135	20x 20 - 155x135
Shortest residual piece length	mm	70	70



Manually adjustable measuring stop, e.g. with a cut piece length of 1,000 mm

NC measuring stop for cut piece lengths up to 1,000 mm (option),
alternatively available for up to 3,000 mm (option)

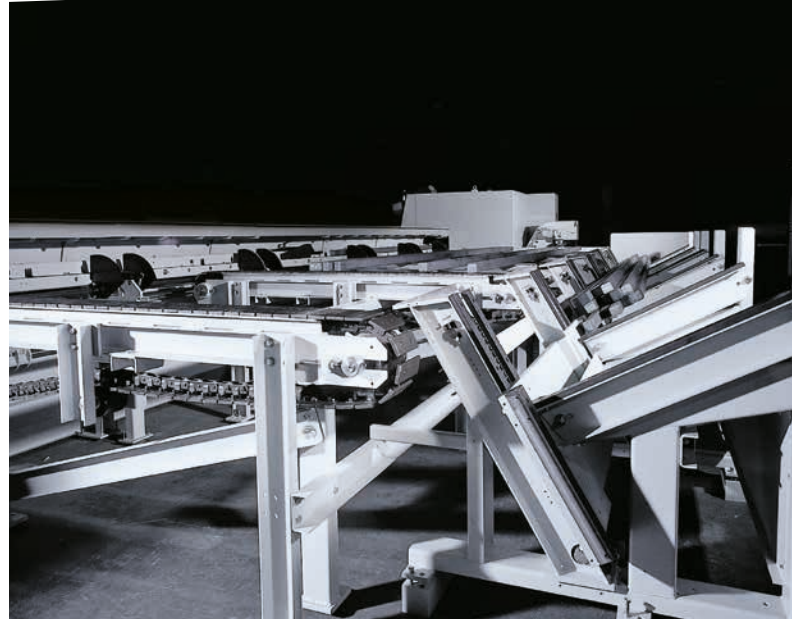

Flat magazine in combination with a bundle loader (option)



Double roller conveyor for automatic material change

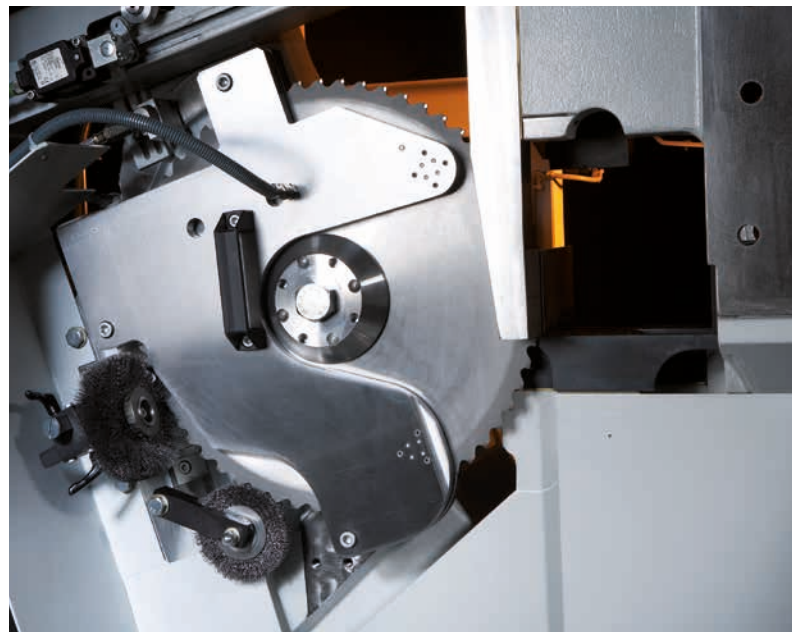

Equipment details and accessories

Material supply adapted to the task:

Various magazine variants are available to help store large raw material quantities in front of the machine. There are different options for long, unstaffed operation, from inclined magazines, on which one layer of material can be placed, bundle loaders, in which a bundle of material is separated fully automatically, to flat magazines for rectangular and special profiles as well as for materials with delicate surfaces.

With direct supply from a KASTO storage system, several material bundles can be processed one after the other fully automatically.

Unstaffed outfeed and sorting - an important prerequisite for effective handling.

Trim cuts and remnants are separated from the good pieces at the outfeed side. According to the cut-off length and cutting task a sorting slide or a tilting table can be offered. More containers for good cut-off pieces can optionally be positioned in the discharge area. An even higher grade of automation offers a robot sorting device which stacks the parts with different grippers according to the cutting requirement into customer-provided containers.



Bundle loader with material in loading position.



Flat magazine for rectangular and special profiles

Tilting table for long cut pieces.



Tilting table with prismatic transfer device and scrap container

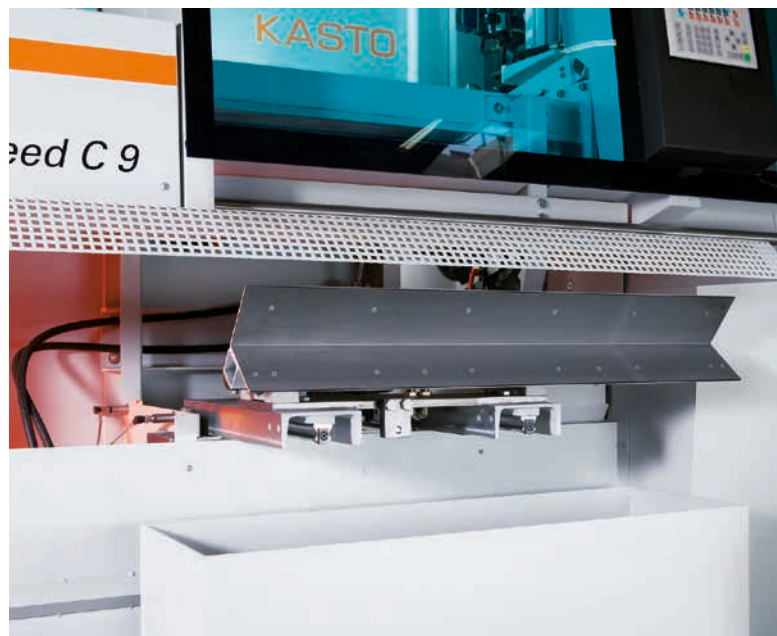

It's not just the saw that is highly effective.

Successful use of the KASTOspeed circular saw machine starts with an expert debriefing based on comprehensive technological competence, cutting tests and many years of experience in a wide variety of tasks. Here, synergies with other business areas are used in the material supply, bar stock storage supply and fully automatic cut piece sorting and stacking with robots.

The KASTO control, developed in-house, which runs on proven industrial hardware, provides long-term benefits, even with later adjustments and extensions.

Chip disposal and environmental protection.

Robust chip conveyors and powerful suction devices in various designs are available for the disposal of chips produced during sawing. To reduce the air emission values, electrostatic air filters are used.

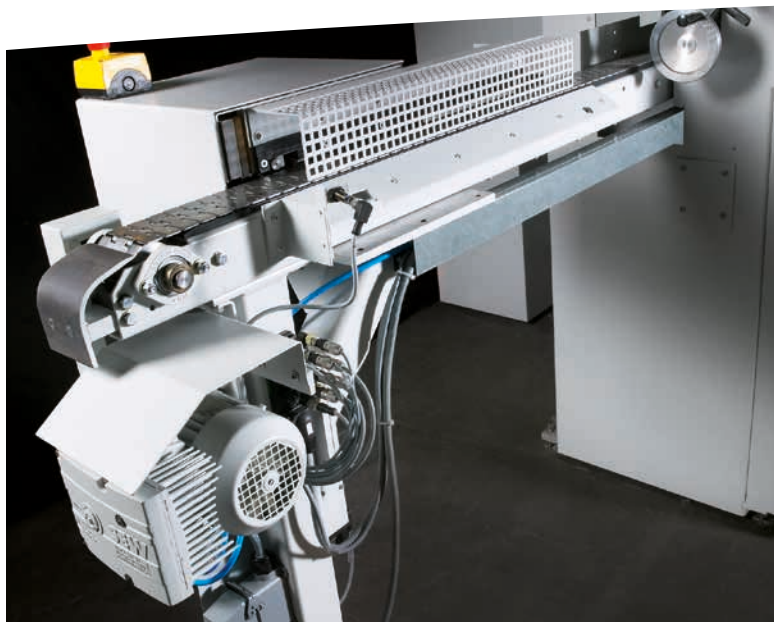

Cut piece outfeed conveyor with sliding device ("to the left" version)

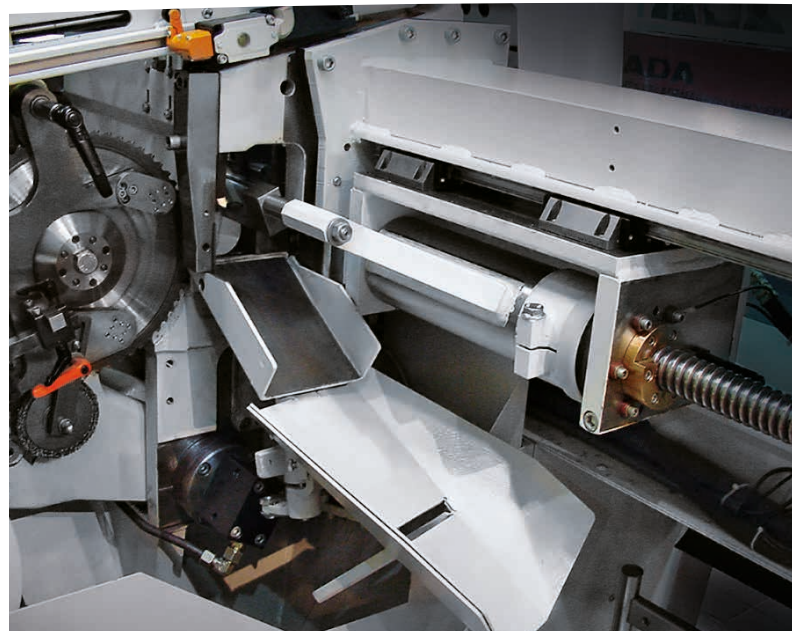

Sorting switch for remnants, good parts and trim cuts

Cut piece removal with a specially developed vacuum gripper

Sorting device with several container locations for cut-off pieces

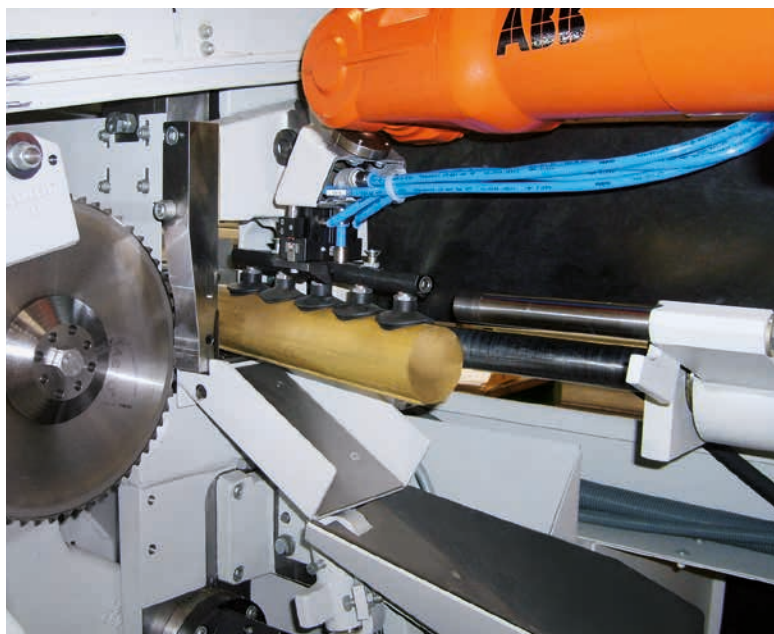



KASTOvariospeed

Fully automatic production circular saw

Automatically adapting to constantly changing requirements is part of what we do: the fully automatic production circular saw for high performance requirements with small to medium order sizes. Regardless

of the material quality, shape and dimensions, the KASTOvariospeed processes quickly changing orders fully automatically and with little manpower. Carbide-tipped or HSS circular saw blades can be used. The

Technical Data		KASTOvariospeed C 15 / C 18
Cutting range		
round (option ø 180 mm)	mm	10 - 152 / 20 - 180
square (option ø 180 mm)	mm	10 x 10 to 135 x 135 / 20 x 20-140 x 140
flat (option ø 180 mm)	mm	10 x 10 to 155 x 120 / 20 x 20-180 x 140
Dimensions and weights		
Length x width x height	mm	10,600 x 4,420 2,340
Shortest residual piece length	mm	40
Saw blade diameter (HM/HSS)	mm	360 - 460
Material support height	mm	950
Weight without feed device	kg	3,900
Performance characteristics		
Total connected load with basic features	kW	28
Saw drive freq.-controlled with overload protection	mm	900
Infinitely adjustable cutting speed	m/min	8 - 150
Saw feed, infinitely adjustable	mm/min	16 - 1,000
Rapid return	mm/min	7,000



ProControl sawing machine control, with its clear and easy operating system, allows users to store up to 500 items of material data for carbide and HSS sa-

wing tools, manage up to 200 orders, add rush orders and visualise system states.

The specialist for fast order processing

- The heavy machine stand and high-performance components form the basis for high cutting performance and long service life of the saw blades
- Frequency-controlled 18 kW three-phase motor with proven high-performance spur gear.
- Preloaded ball screw for minimum non-productive times, automatic adjustment of the feed path to the workpiece dimensions and shape, rapid return after sawing through
- Precise cut pieces thanks to optimal and patented saw blade guidance when the saw blade enters and exits
- NC material feed with pulling tongs, cut piece lengths from 7 to 2,000 mm in one go, minimum residual piece length only 40 mm
- Tilting table for sorting the cut pieces
- Sorting area within the cut piece length pulling route
- Pro Control sawing machine control (*ExpertControl* option)
- System diagnostics for all operating states, error messages in plain text
- Allocation of the cutting technology for the corresponding material qualities according to DIN or steel code of the saw blade used (HSS or carbide)



KASTOvariospeed C 15 / C 18

For material cross-sections up to 150 mm / 180 mm



Material supply

The right material supply for every requirement. The material supply with round material is carried out by an inclined magazine and thus ensures low-staff operation.

An automatic universal magazine enables a diverse supply of material in different workpiece dimensions,

shapes and qualities. Further options for unstaffed material supply exist with direct integration into a KASTOcenter (combination of saw and storage).

Technical Data		KASTOvariospeed C 15 / C 18
Cutting range		
round (option ø 180 mm)	mm	10 - 152 / 20 - 180
square (option ø 180 mm)	mm	10 x 10 to 135 x 135 / 20 x 20 - 140 x 140
flat (option ø 180 mm)	mm	10 x 10 to 155 x 120 / 20 x 20 - 180 x 140
Dimensions and weights		
Length x width x height	mm	10,600 x 4,420 2,340
Total connected load with basic features	kW	28

Cut piece sorting options

Every cut piece in the right place. The sorting of cut pieces within the sawing machine saves a lot of space. The sorting section length is 2,000 mm on both sides in the direction of material flow. All cut pieces up to 2,000 mm are automatically sorted into one or more positions depending on length. Trim cuts and remnants are disposed of separately. The KASTO

cross sorting system is a low-noise, low-burden storage solution for heavy cut pieces. After sawing, long cut pieces can be pushed off automatically on storage tables.



KASTO universal magazine



KASTO inclined magazine



Low-noise placement of heavy workpieces...



... with KASTO cross sorting (option)

Sorting of long cut pieces inside the machine

Sorting of long cut pieces outside the machine.

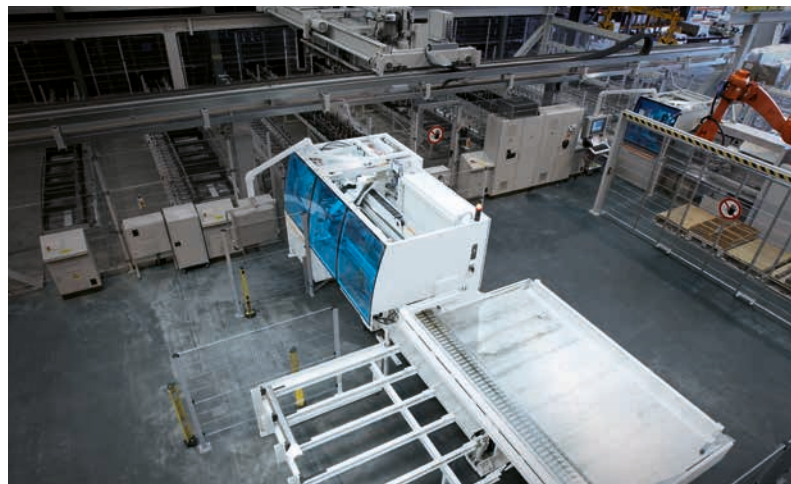

KASTOsort

Handling competence for sawing machines and storage technology thanks to industrial robots integrated by KASTO

KASTOsort offers the option of palletising the full cut piece range of your KASTO sawing machine without additional operating effort, or transferring it to other processing systems.

Our experience of integrating more than 100 industrial robots in sawing systems worldwide, the highly flexible program structure and innovative gripping concepts allow a virtually infinite variety of possibilities. Regardless of whether flat material, discs or rods are to be stacked, deburred or marked: thanks to the decentralised, self-organising program logic and the multi-stage gripper change concept, the system reacts intelligently to each new cut piece dimension.

KASTOsort is firmly integrated into the KASTO system world. This enables the operating personnel to monitor and control the robot system during operation in a way that is as simple as it is clear.

The cut piece container stacking pattern is automatically regenerated and optimised for any dimension and container. The containers in which the cut pieces are stacked can be freely selected.

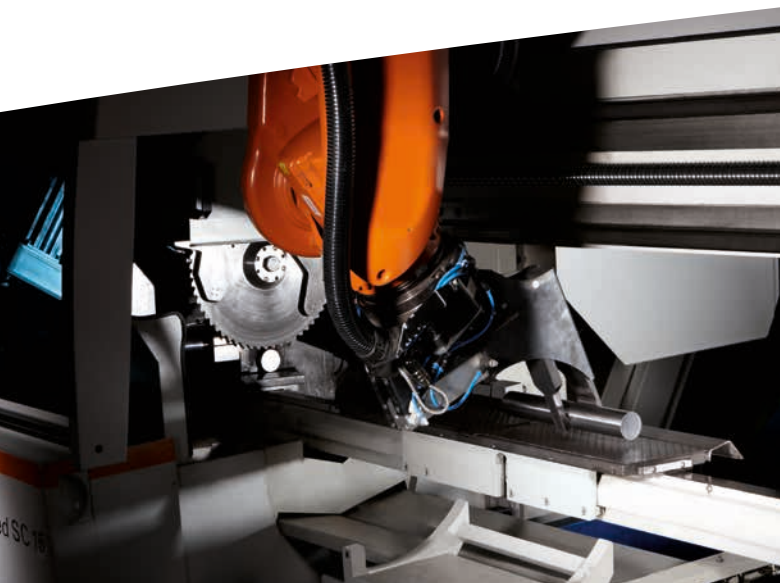

Complete process integration and individual adaptability

To complete your automation needs, the robot handling system can be expanded with subsequent processes. In addition to the handling processes such as palletising, loading and picking, the following processes are available to you:

- Chamfering, deburring
- Centre drilling
- Cleaning, vacuuming pipes
- Weighing, (length) measurement
- Labelling, printing
- Pin marking
- And much more

If a standard solution cannot be used to automate work processes, our developers can create optimal customised solutions and strategies.

You can find more about KASTO's smart solutions in the brochure "*KASTO SmartSolutions - Innovative, digital solutions*"

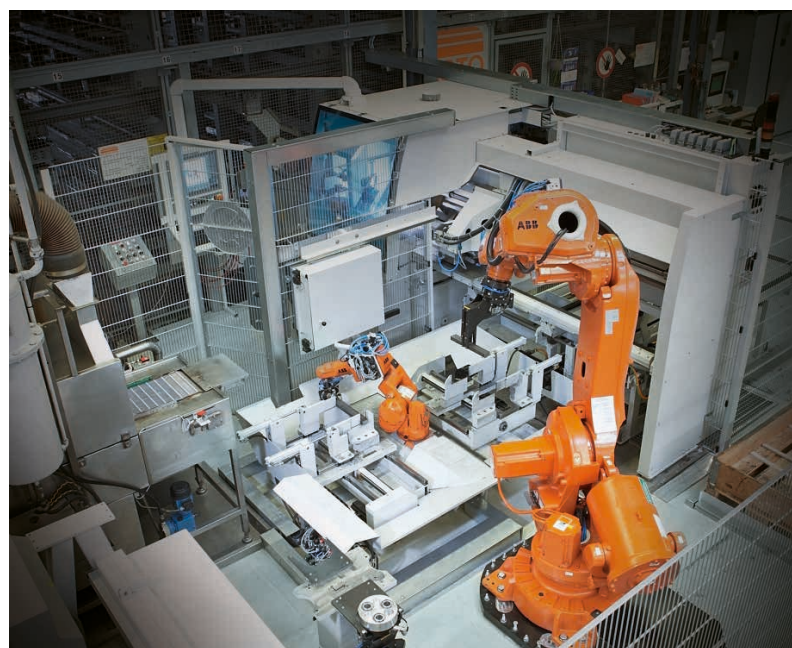

KASTO Saws. Storage. And more.

Competence along the entire line

KASTO has stood for quality and innovation for 180 years. Alongside metal saws and automatic storage systems for bar stock and sheet metal, KASTO offers customised material logistics solutions. The product portfolio is rounded off by intelligent software solu-

tions and KASTO's first-class service. KASTO's continuous development of new technologies and permanent optimisation of machine concepts has made it the world market leader in sawing and storing metal.

Sawing machines from KASTO



The KASTO saw portfolio includes hacksaws, band saws and circular saws, from workshop saws to powerful fully automatic machines. www.kasto.com/saws

KASTO storage solutions



All KASTO storage systems are characterised by fast access, high space utilisation and a good storage overview. www.kasto.com/storage

KASTO Service



Rapid availability of spare parts and individual support come as a matter of course. *KASTOretrofit* adapts your proven systems to current requirements. www.kasto.com/service

KASTO SmartSolutions



KASTO offers numerous digital automation solutions to make metal processing and storage more efficient, flexible and cost-effective. www.kasto.com/smart

Your KASTO partner:

KASTO Maschinenbau
GmbH & Co. KG
Industriestr. 14
DE-77855 Achern
+49 7841 61-0
kasto@kasto.com
www.kasto.com

